

T70

**700 KG
1543 LBS**

IT Motori termici più performanti e una grande potenza idraulica a tre stadi permettono al minidumper T70 di trasportare facilmente carichi fino a 700 kg. La macchina ideale per essere utilizzata su cantieri edili, giardinaggio, agricoltura o garden design.

EN More effective thermal engine and a great three-stage hydraulic power ensure to T70 minidumper to carry easily up to 1543 lbs loads. The ideal machine to be used in construction sites, landscaping, agriculture or garden design.

Sistema autocaricante
Self-loading system

Joystick

Sottocarro rinforzato
Heavy duty undercarriage

Equipaggiato con / Equipped with:
Honda 8,4 HP

Cassone con sponde apribili
Farm bed skip

Sovraspanda
Extra overboard

1

Motorizzazione a benzina
Gasoline engine

2

Avviamento elettrico
Electric starting

3

Due pompe port. var. + 1 pompa ingr.
Two var. displ. pumps + 1 gear pump

4

Trasmissione idrostatica
Hydrostatic transmission

5

Rulli oscillanti
Rocking rollers

VANTAGGI / ADVANTAGES

T70 • MINIDUMPER

CNF—CONSTRUCTION EQUIPMENT

CNF—CONSTRUCTION EQUIPMENT

T70 • MINIDUMPER

5



Versioni disponibili · Available models

T70

MINIDUMPER

**CAPACITÀ OPERATIVA
OPERATING WEIGHT
700 KG · 1543 LBS**

**LARGHEZZA AI CINGOLI
TRACK WIDTH
680 MM · 26.7 INCH**

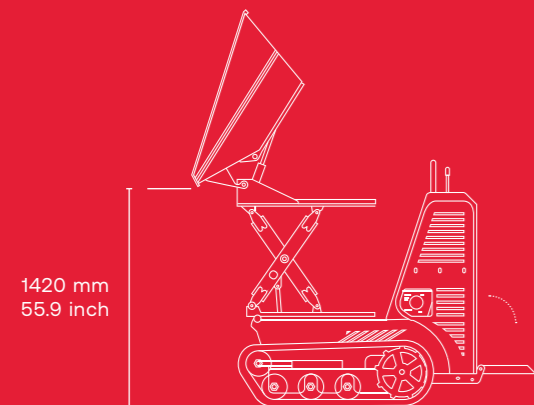
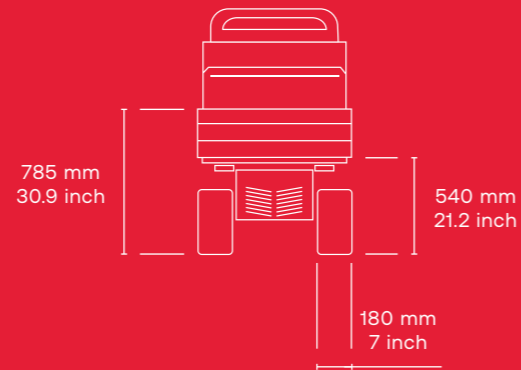
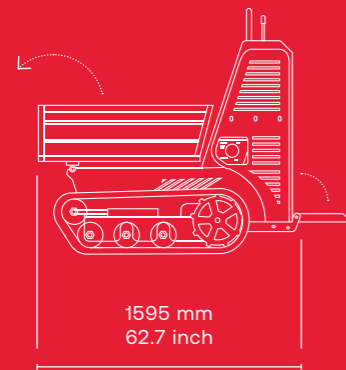
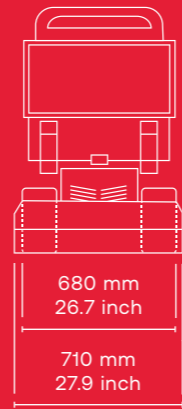
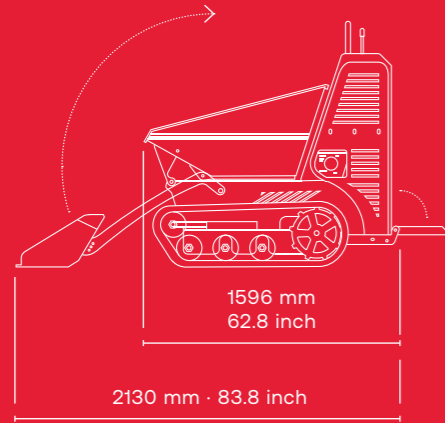

MOTORE TERMICO ENGINE

→ HONDA GX270

TRASMISSIONE TRANSMISSION

→ IDROSTATICA
→ HYDROSTATIC

POMPA IDRAULICA HYDRAULIC PUMP

→ 2xPORT. VAR. + 1 POMPA INGR.
→ 2xVAR. DISPL. + 1 GEAR PUMP

MOTORE IDRAULICO HYDRAULIC MOTOR

2 x ORBITALI
2 x ORBITAL

PORTATA POMPA PUMP FLOW RATE

→ 2x25 L/MIN + 1 POMPA INGR.
→ 3x6 GPM + 1 GEAR PUMP

PRESSIONE MASSIMA MAX PRESSURE

180 bar

RAFFREDDAMENTO IDRAULICO HYDRAULIC COOLING SYSTEM

ARIA
AIR

LARGHEZZA CINGOLI TRACK WIDTH

180 mm
7 inch

RULLI TRACK ROLLERS

3

RULLI OSCILLANTI ROCKING ROLLERS

→ SI
→ YES

REGOLAZIONE CINGOLI TRACK TENSIONER

SI
YES

2 VELOCITÀ DI TRASLAZIONE 2 TRAVEL SPEED

3.5 km/h
2.2 mph

CAPACITÀ OPERATIVA OPERATING WEIGHT

→ 700 KG / 1543 LBS

HIGH-TIP

→ 600 KG / 1322 LBS

MASSA A VUOTO EMPTY WEIGHT

355 kg
749 lbs

CONTROLLO CONTROL

→ MONOJOYSTICK

CARATTERISTICHE TECNICHE / TECHNICAL FEATURES

 RASO 0.24 m³
STRUCK 0.31 yd³

 COLMO 0.30 m³
HEAPED 0.39 yd³

 RASO 0.12 m³
STRUCK 0.15 yd³

 COLMO 0.20 m³
HEAPED 0.26 yd³

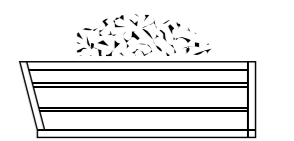
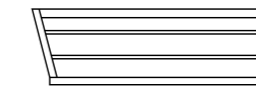
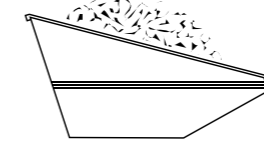
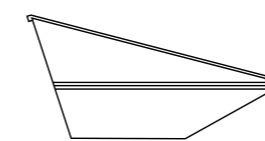

 RASO 0.21 m³
STRUCK 0.27 yd³

 COLMO 0.29 m³
HEAPED 0.37 yd³

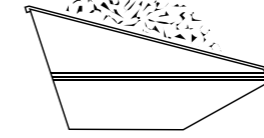
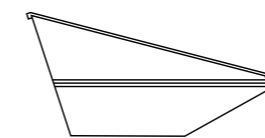

CAPACITÀ / CAPACITY