

T50

MINIDUMPER

**CAPACITÀ OPERATIVA
OPERATING WEIGHT
500 KG · 1102 LBS**

**LARGHEZZA AI CINGOLI
TRACK WIDTH
680 MM · 26.7 INCH**

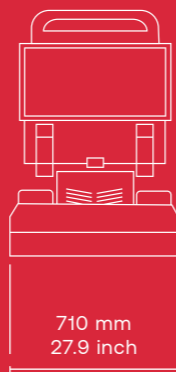
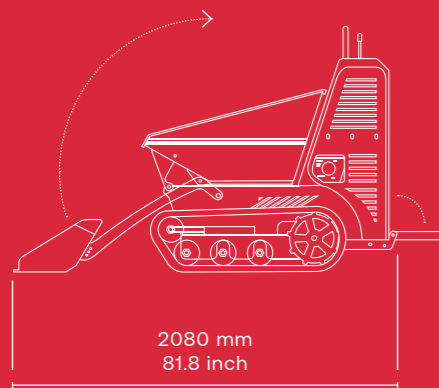
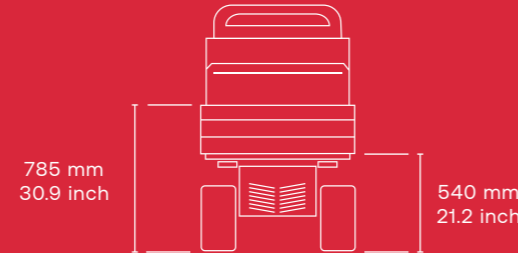
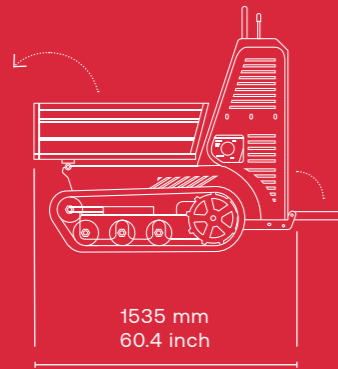
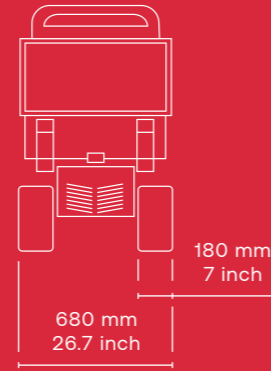
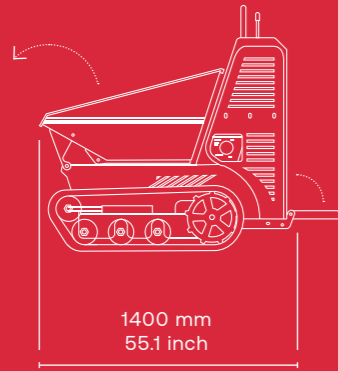

MOTORE TERMICO ENGINE

- HONDA GX240
- YANMAR L70

TRASMISSIONE TRANSMISSION

- IDROSTATICA
- HYDROSTATIC

POMPA IDRAULICA HYDRAULIC PUMP

- 3 X INGRANAGGI
- 3 X GEAR PUMP

MOTORE IDRAULICO HYDRAULIC MOTOR

- 2 x ORBITALI
- 2 x ORBITAL

PORTATA POMPA PUMP FLOW RATE

- 3 x 14 l/min
- 3 x 3.8 gpm

PRESSIONE MASSIMA MAX PRESSURE

180 bar

RAFFREDDAMENTO IDRAULICO HYDRAULIC COOLING SYSTEM

- ARIA
- AIR

LARGHEZZA CINGOLI TRACK WIDTH

- 180 mm
- 7 inch

RULLI TRACK ROLLERS

3

RULLI OSCILLANTI ROCKING ROLLERS

- SI
- YES

REGOLAZIONE CINGOLI TRACK TENSIONER

- SI
- YES

2 VELOCITÀ DI TRASLAZIONE 2 TRAVEL SPEEDS

- 2.5 – 3.5 km/h
- 1.55 – 2.2 mp/h

CAPACITÀ OPERATIVA OPERATING WEIGHT

- 500 kg
- 1102 lbs

MASSA A VUOTO EMPTY WEIGHT

- 340 kg
- 749 lbs

CARATTERISTICHE TECNICHE / TECHNICAL FEATURES

 RASO 0.22 m³
STRUCK 0.28 yd³

 COLMO 0.29 m³
HEAPED 0.37 yd³

 RASO 0.15 m³
STRUCK 0.19 yd³

 COLMO 0.23 m³
HEAPED 0.30 yd³

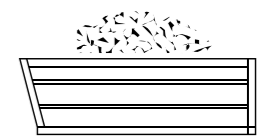
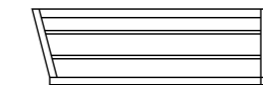
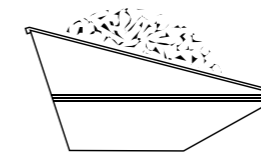
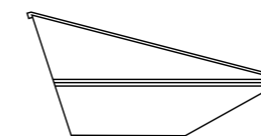

CAPACITÀ / CAPACITY